

# ARTWORK APPROVAL FORM



## ORDER DETAILS

ORDER NUMBER: X  
 ITEM CODE: CAL002-XD  
 QUANTITY: X  
 RINGS:  X  
 X: X

## COVER (A1/B1/C1/D1)

TECHNIQUE: OFFSET  
 COLOUR: CMYK  
 SIZE: ALL OVER  
 LAMINATION: SHINY / MATT  
 X: X

## STICKY NOTES (E1/F1/G1/H1)

TECHNIQUE: X  
 COLOUR: -  
 SIZE: AS ARTWORK  
 PAPER TYPE: WHITE  
 X: X

## SHEETS (I1.1-I1.12 / I2.1-I2.12)

TECHNIQUE: X  
 COLOUR: CMYK  
 SIZE: AS ARTWORK  
 X: X  
 X: X

X  
 X  
 X  
 X  
 X  
 X

SCALE 1:2

### GENERAL COMMENTS:

THE FINAL OUTCOME OF THE COLOURS WILL BE AFFECTED DEPENDING OF THE LAMINATION TYPE.

DUE TO THE NATURE OF FULL COLOUR PRINTING THE OUTCOME OF THE FINAL COLOUR RESULT CAN BE SLIGHTLY DIFFERENT IN A REAL SAMPLE.

WATERMARK EFFECT MIGHT BE DIFFERENT FROM EXPECTATION. THE FINAL EFFECT CAN BE TOO DARK OR TOO BRIGHT.

### ATTENTION:

## SKETCH OF COMPONENT PLACEMENT

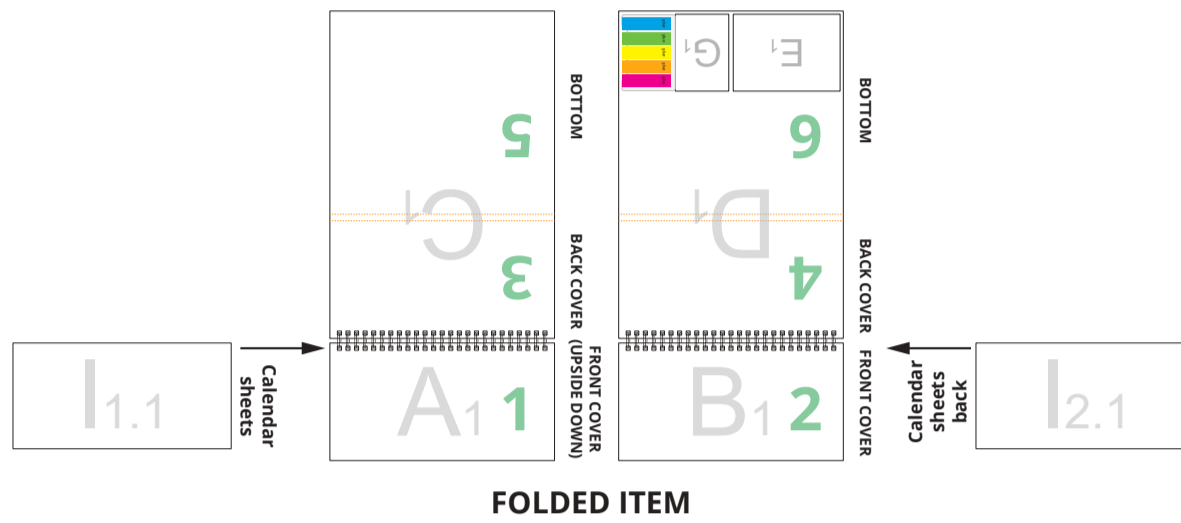
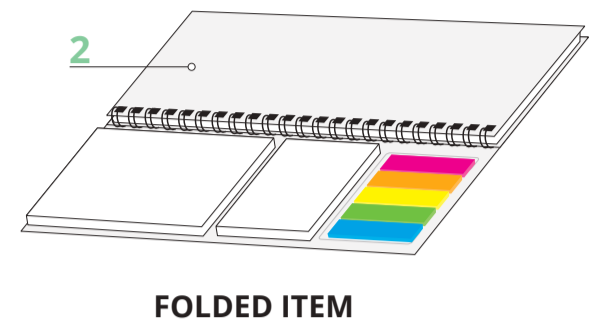
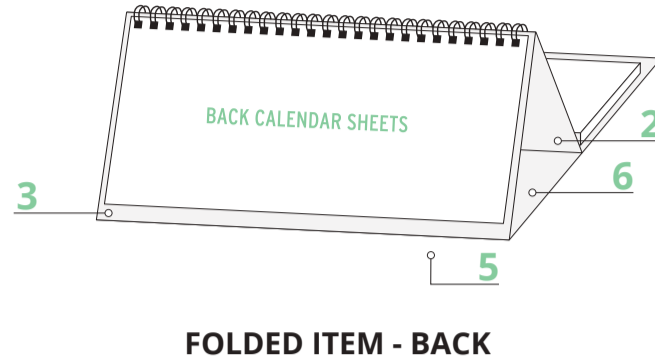
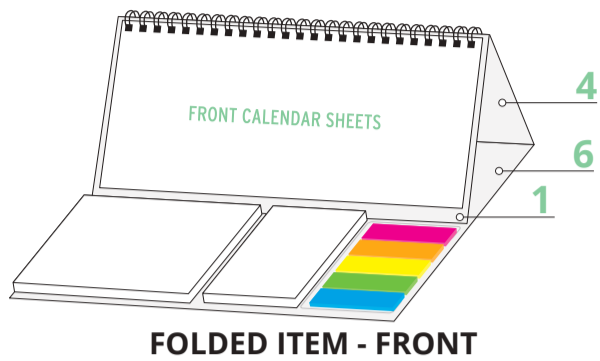

### OUTER COVER

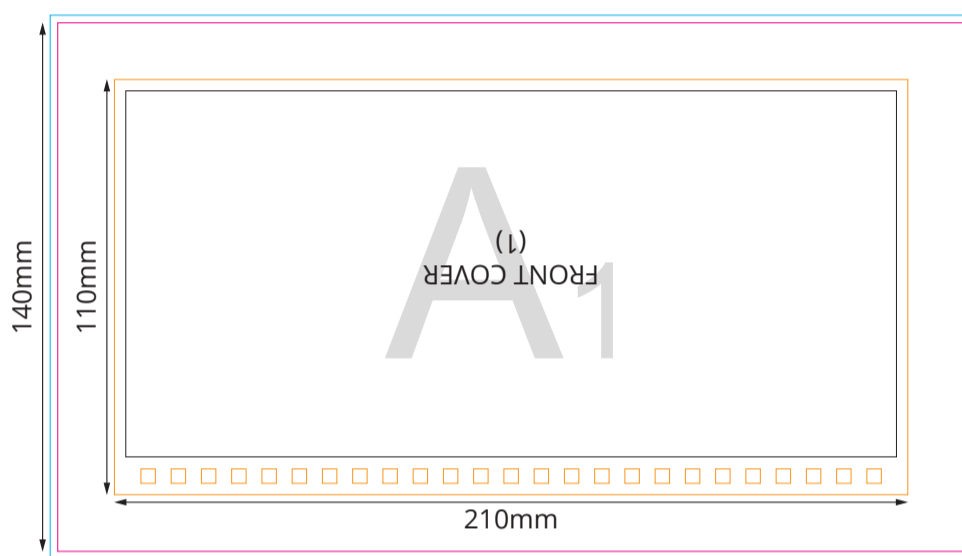

### INNER COVER

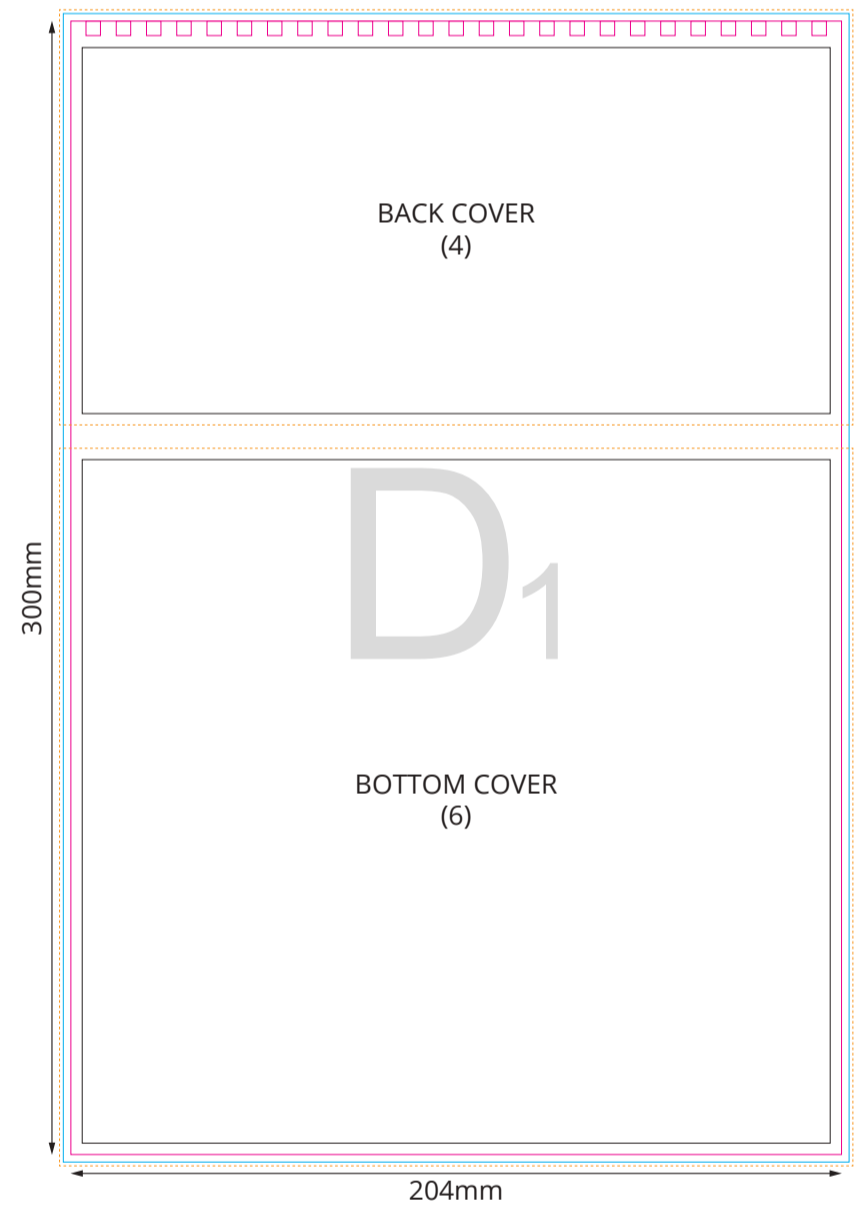
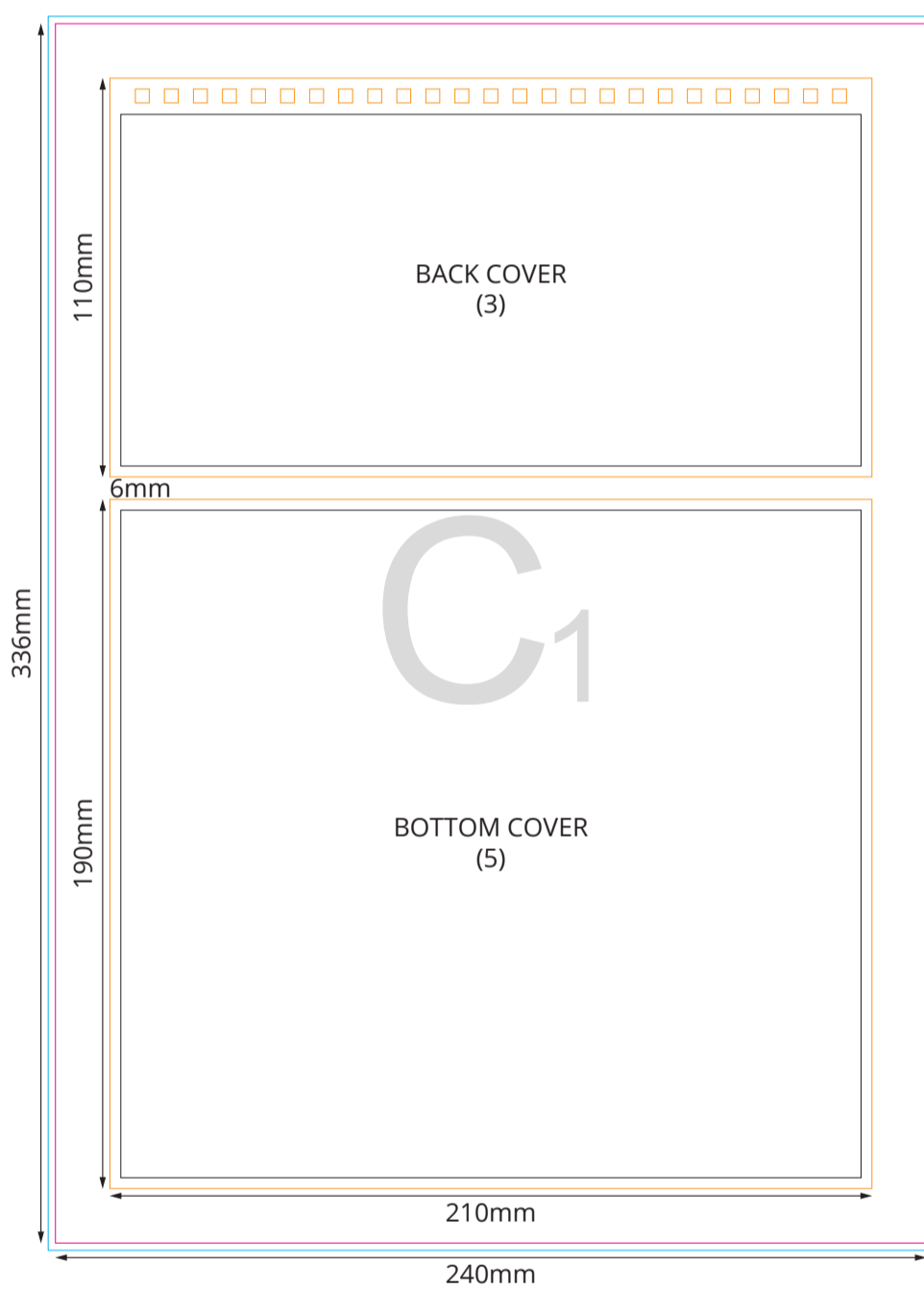
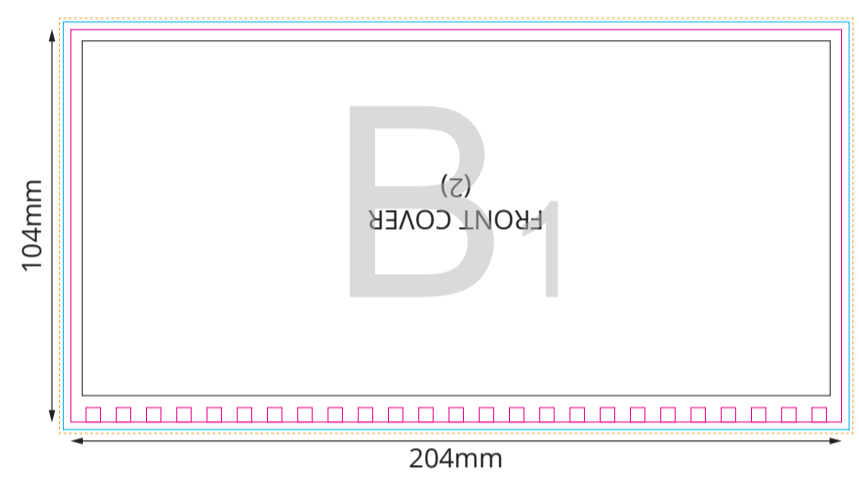

**yourChoice**

### STICKY NOTES

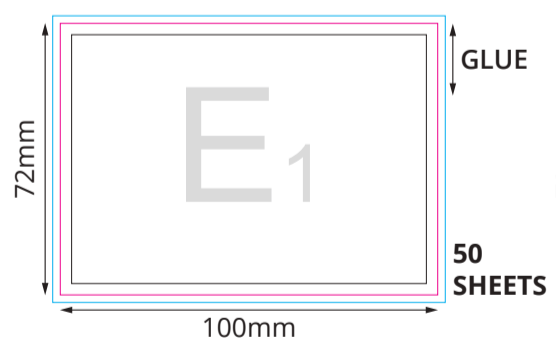

### BOTTOM SHEET (UNPRINTED)

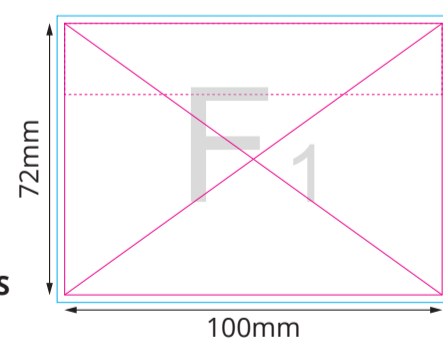

### STICKY NOTES

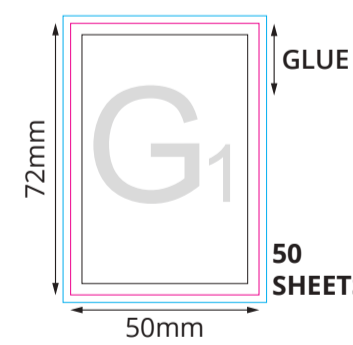

### BOTTOM SHEET (UNPRINTED)

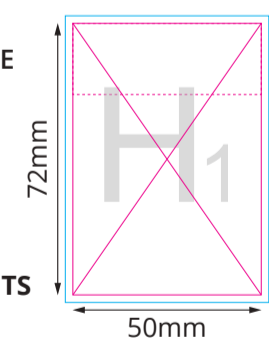

### CALENDAR SHEETS - BACK

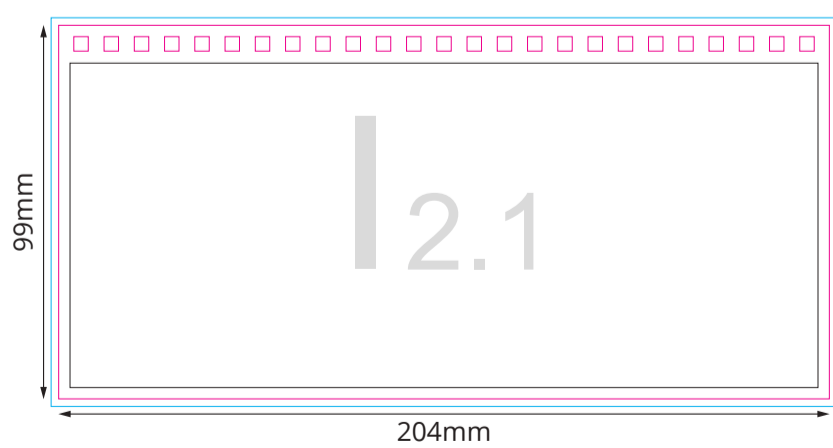

### CALENDAR SHEETS - FRONT

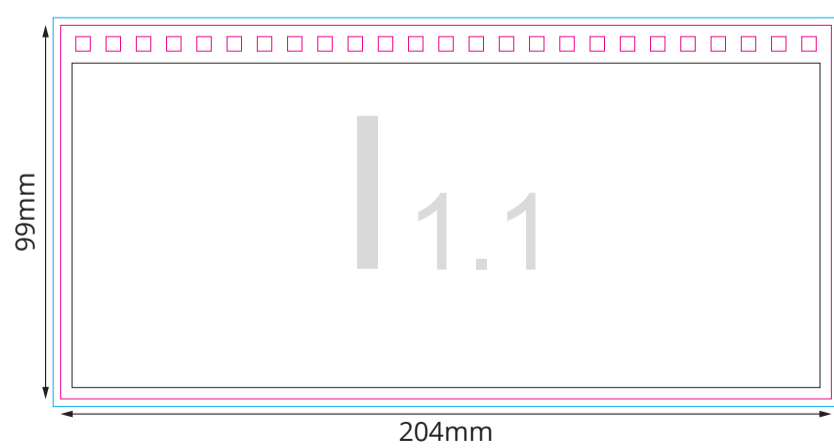

### Key:

- Finished component size
- Bleed area. In case of bleed imprint, please extend it until blue line
- Safe print area. Keep all important text and graphics within this area
- Solid board
- Edge of solid board



A<sub>1</sub>



B<sub>1</sub>

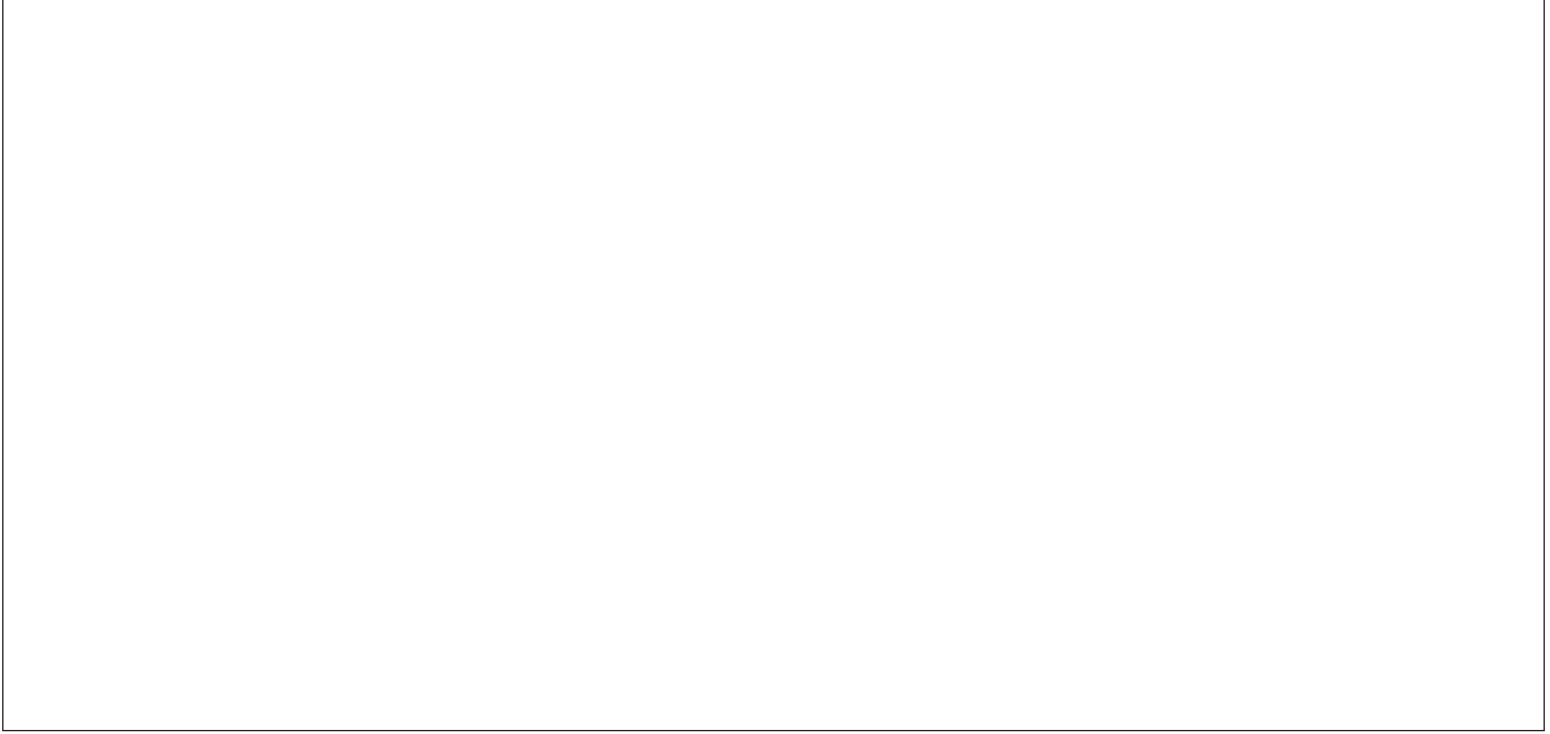

C<sub>1</sub>

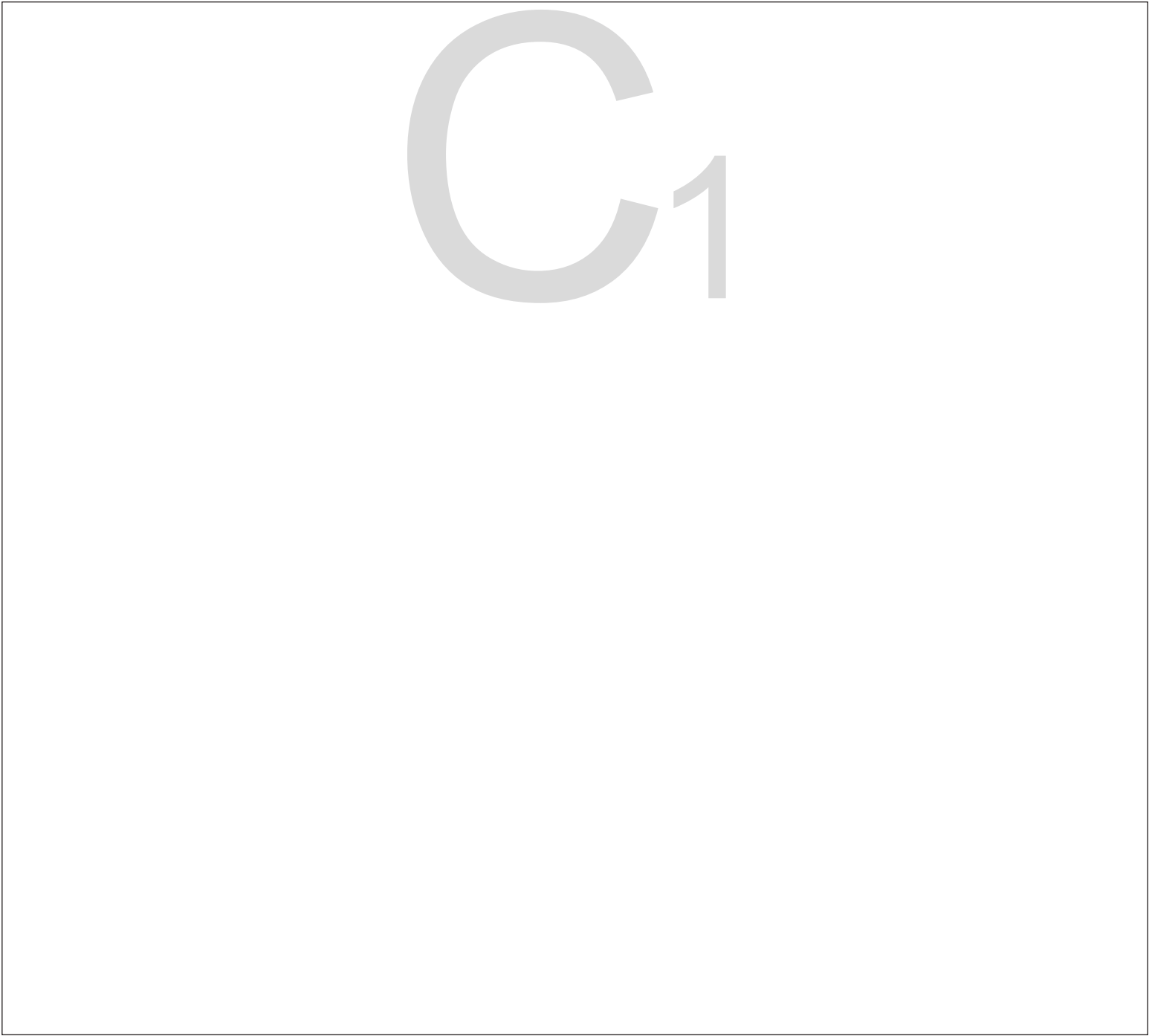

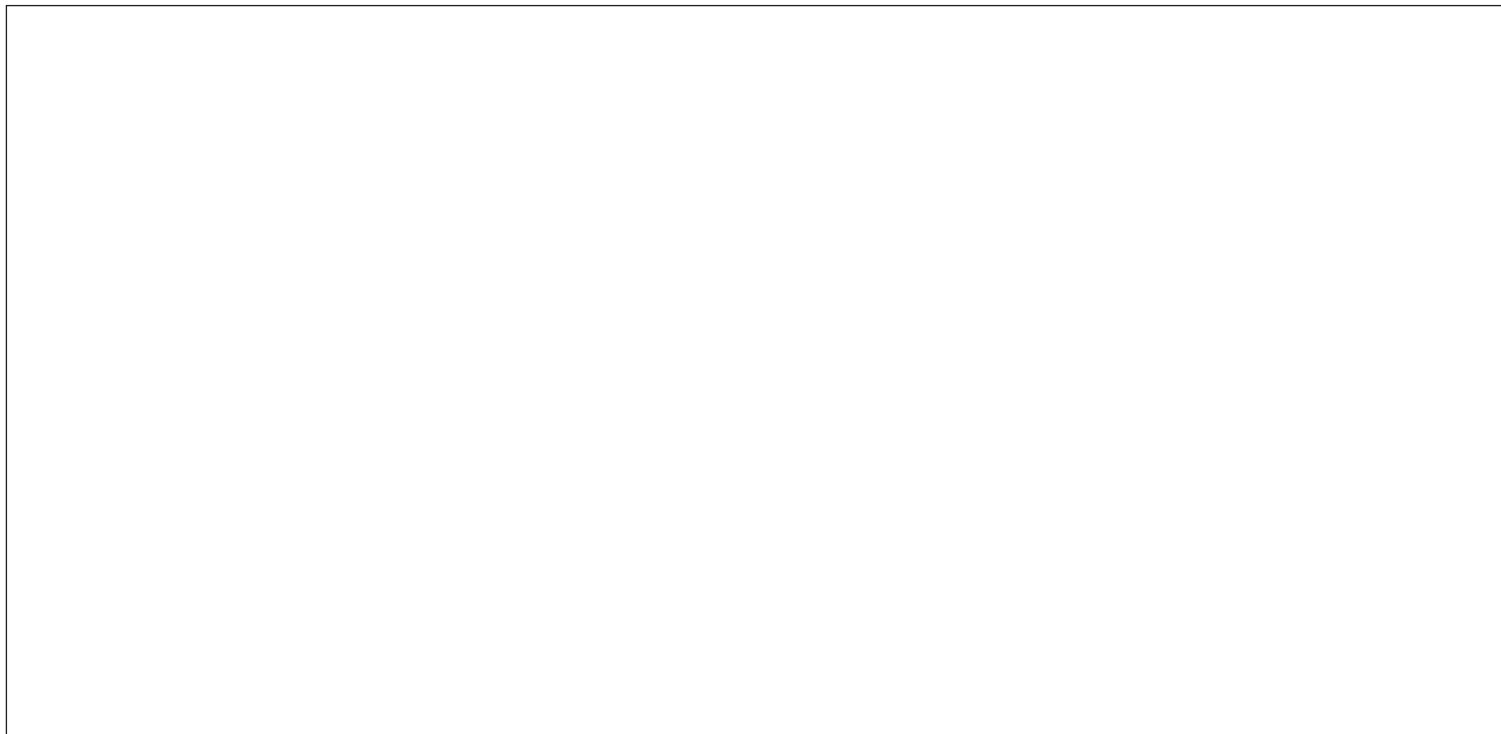

D<sub>1</sub>

$E_1$

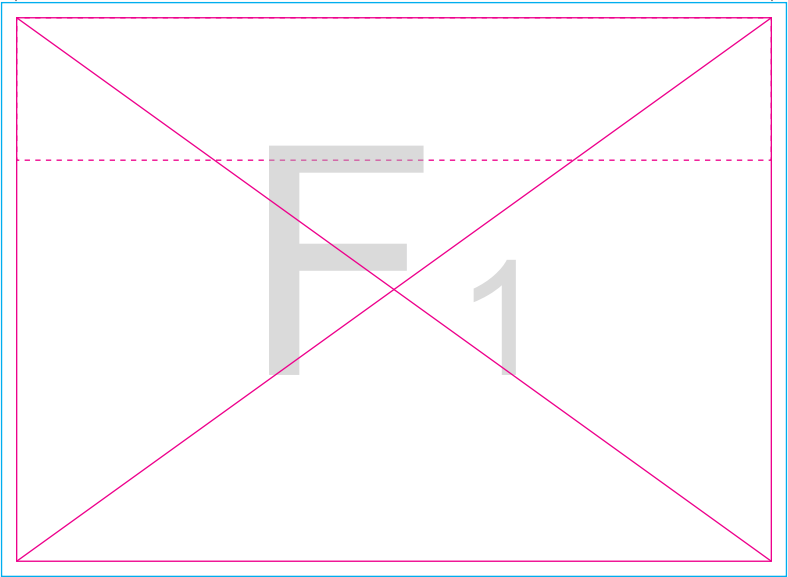

F1

G<sub>1</sub>



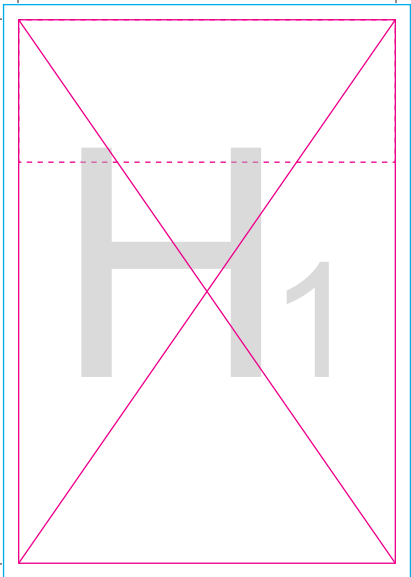



1.1



12.1



1.2



12.2



1.3



1.2.3



1.4



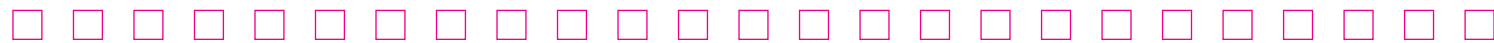

12.4

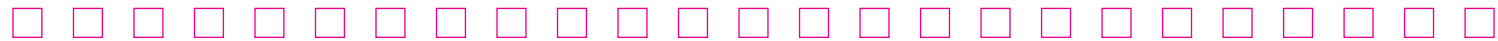

1.5

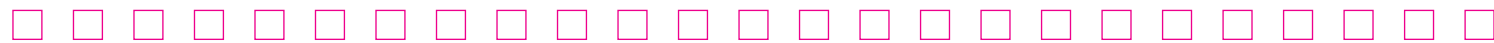

1 2.5

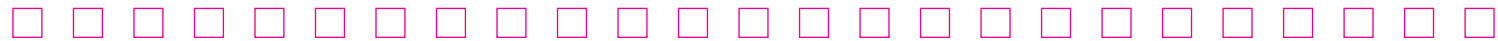

1.6



12.6



1.7



12.7



1.8





12.8



1.9



12.9



1.10



| 2.10



1.11



| 2.11



1.12





| 2.12